

Addressable SK6812 RGBW LED strip 60LEDs/M DC12V

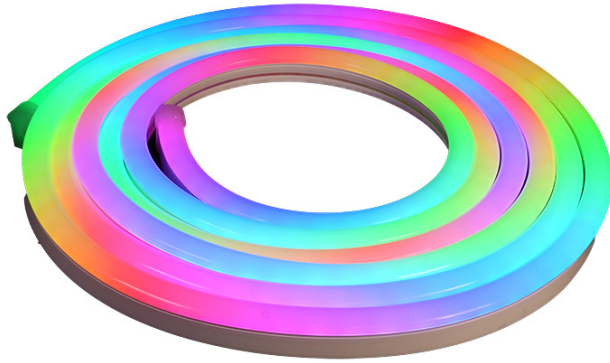

◆ Product Description :

This led strip with 60pcs high quality SMD5050 RGBW LED chips

Use SPI controller, 60Pixels/m, 1 LED per section

Input voltage is DC12V

Flexible PCB with white / black color

1+2 ounce copper FPC, 12mm width

Standard 5M/roll, length can be customized

◆ Product Datasheet

Product Number	L054	Luminance/M	R:62 G:163 B:45 W:333lm
Operating Voltage	DC12V	Ra	/
Power/M	32W	Beam Angle	120°
SMD Type	5050	Size (mm)	5000 *14 *25mm
LED Qty/M	60	IP Rate	IP65
Color	RGBW:3000K/4000K/6000K	Operation Temperature	- 25 ~ 60 °C
Pixel/M	60	Material	FPC
Control	SPI/SK6812	Cutting Length	16.66mm
Wavelength	R:620-625 G:520-525 B:460-465nm	Net Weight/Roll	1.6 kg

◆ Outline Dimension (unit : mm)

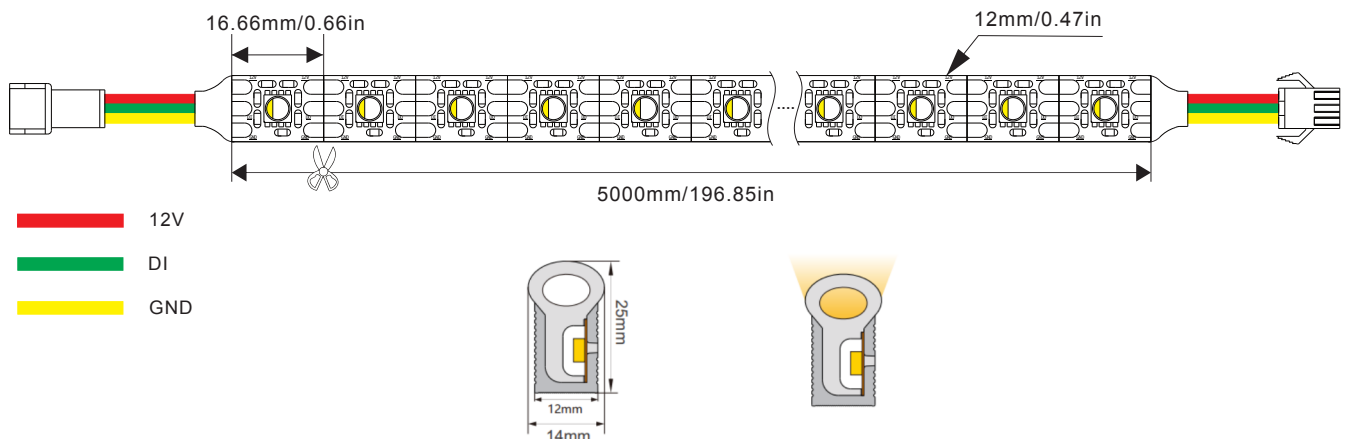

◆ Available in:

DC12V	RGB+3000K	White PCB	IP65	STANDARD
DC12V	RGB+4000K	White PCB	IP65	
DC12V	RGB+6000K	White PCB	IP65	

◆ SDCM comparison



◆ Light distribution curve

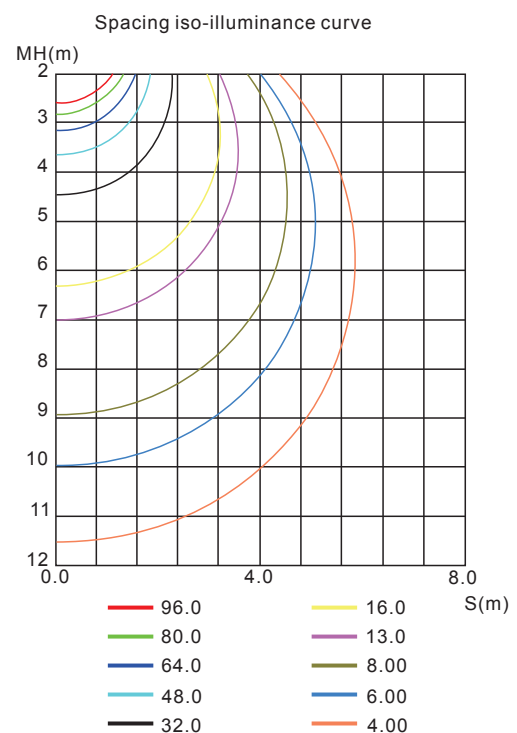
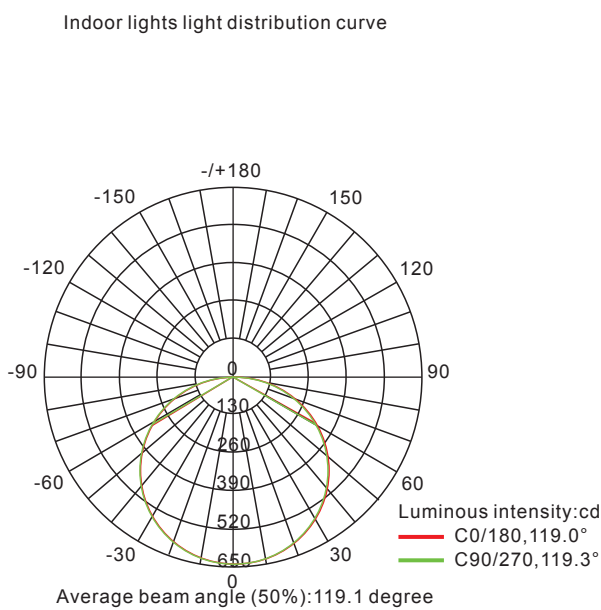

Note: The parameters are subject to change without notice!

◆ Wiring diagram

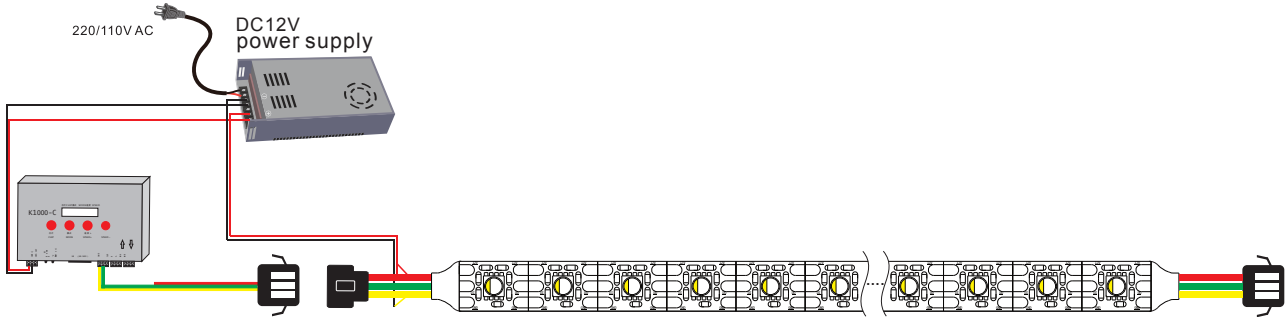

◆ Strip IP Rate

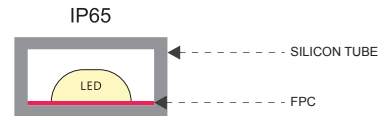

◆ Accessories



Screw



Silicone clip



End cap

◆ Schematic diagram of maximum bending prevention

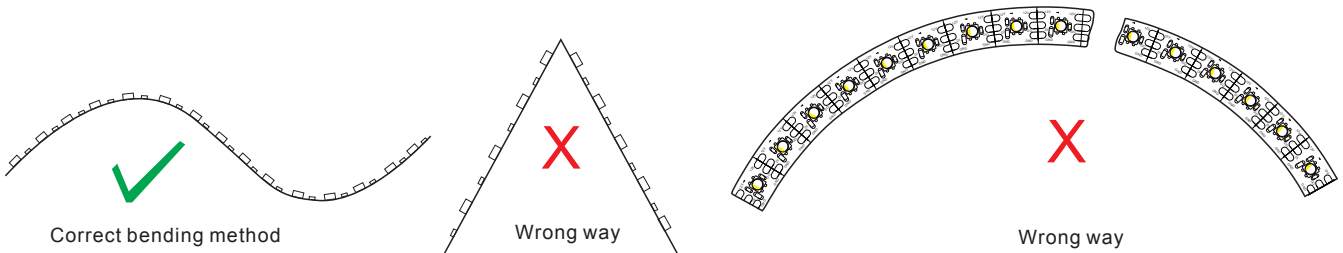

Product number	Standard length	Quantity / volume	Outer carton size	Weight(kg)/reel
L054	5M	120 roll	L470xW270xH470mm	0.24kg
/				/
/				/
/				/
/				/
/				/